



Male Pipe (NPTF - 30° Cone Seat)



Part No.	Descr.	Prod. No.	⊖		H1	L		C		
			"	mm		"	mm	"	mm	
G27100-0402	4C1T-2RMP	7231-81241	1/4	6.4	1/8-27	1/2	2.30	58.4	1.29	32.8
G27100-0404	4C1T-4RMP	7231-81210	1/4	6.4	1/4-18	9/16	2.52	64.0	1.51	38.4
G27100-0604	6C1T-4RMP	7231-81242	3/8	9.5	1/4-18	9/16	2.68	68.1	1.54	39.1
G27100-0606	6C1T-6RMP	7231-81211	3/8	9.5	3/8-18	11/16	2.53	64.3	1.39	35.3
G27100-0806	8C1T-6RMP	7231-81243	1/2	12.7	3/8-18	11/16	3.05	77.5	1.70	43.2
G27100-0808	8C1T-8RMP	7231-81212	1/2	12.7	1/2-14	7/8	3.06	77.7	1.71	43.4
G27100-0812	8C1T-12RMP	7231-81244	1/2	12.7	3/4-14	1 1/16	3.13	79.5	1.87	47.5
G27100-1212	12C1T-12RMP	7231-81213	3/4	19.1	3/4-14	1 1/16	3.19	81.0	1.73	43.9
G27100-1616	16C1T-16RMP	7231-81214	1	25.4	1-11 1/2	1 3/8	3.78	96.0	2.10	53.3

Male Pipe Swivel (NPTF - without 30° Cone Seat)

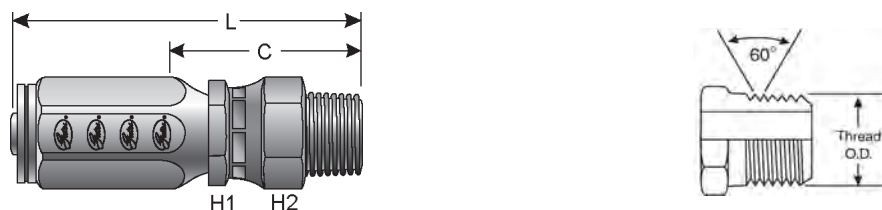

Part No.	Descr.	Prod. No.	⊖		H1	H2	L		C		
			"	mm			"	mm	"	mm	
G27105-0404	4C1T-4RMPX	7231-22445	1/4	6.4	1/4-18	7/16	7/8	3.18	80.8	2.17	55.1
G27105-0606	6C1T-6RMPX	7231-22455	3/8	9.5	3/8-18	5/8	7/8	3.51	89.2	2.23	56.6
G27105-0808	8C1T-8RMPX	7231-22465	1/2	12.7	1/2-14	3/4	1	3.99	101.4	2.63	66.8
G27105-1212	12C1T-12RMPX	7231-22475	3/4	19.1	3/4-14	1 1/16	1 5/16	4.27	108.5	2.73	69.3

- EQUIPMENT
- HOSE/CPLG. SELECTION
- G8K COUPLINGS
- GLOBALSPIRAL COUPLINGS
- STAINLESS STEEL SPIRAL
- MEGACRIMP COUPLINGS
- STAINLESS STEEL BRAID
- POWER CRIMP COUPLINGS
- FIELD ATTACHABLE G1 & G2 COUPLINGS**
- FIELD ATTACHABLE C5 COUPLINGS
- C14 COUPLINGS
- GL COUPLINGS
- GLX COUPLINGS
- PCTS THERMOPLASTIC COUPLINGS
- POLARSEAL COUPLINGS (ACA)
- POLARSEAL II COUPLINGS (ACC)
- POLARSEAL II COUPLINGS (ACB)
- POWER STEERING
- ADAPTERS
- QUICK DISCONNECT COUPLERS
- BALL VALVES
- LIVE SWIVEL
- ASSEMBLY FABRICATION
- ACCESSORIES
- EQUIPMENT AND PARTS
- KITS
- AIR BRAKE HOSE ASSY
- BRASS



EQUIPMENT
HOSE/CPLG. SELECTION
G8K COUPLINGS
GLOBALSPIRAL COUPLINGS
STAINLESS STEEL SPIRAL
MEGACRIMP COUPLINGS
STAINLESS STEEL BRAID
POWER CRIMP COUPLINGS
FIELD ATTACHABLE G1 & G2 COUPLINGS
FIELD ATTACHABLE C5 COUPLINGS
C14 COUPLINGS
GL COUPLINGS
GLX COUPLINGS
PCTS THERMOPLASTIC COUPLINGS
POLARSEAL COUPLINGS (ACA)
POLARSEAL II COUPLINGS (ACC)
POLARSEAL II COUPLINGS (ACB)
POWER STEERING
ADAPTERS
QUICK DISCONNECT COUPLERS
BALL VALVES
LIVE SWIVEL
ASSEMBLY FABRICATION
ACCESSORIES
EQUIPMENT AND PARTS
KITS
AIR BRAKE HOSE ASSY
BRASS

Male O-Ring Boss

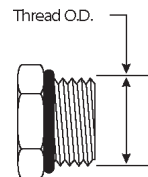
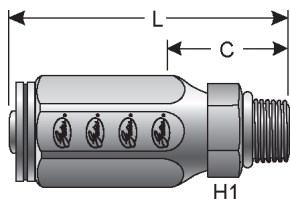

Part No.	Descr.	Prod. No.	⊖		H1	L		C		
			"	mm		"	"	"	mm	"
G27120-0606	6C1T-6RMB	7231-22255	3/8	9.5	9/16-18	11/16	2.52	64.0	1.24	31.5
G27120-0608	6C1T-8RMB	7231-22265	3/8	9.5	3/4-16	7/8	2.59	65.8	1.32	33.5
G27120-0808	8C1T-8RMB	7231-22275	1/2	12.7	3/4-16	7/8	2.87	72.9	1.52	38.6
G27120-0810	8C1T-10RMB	7231-22285	1/2	12.7	7/8-14	1	3.11	79.0	1.76	44.7

Male JIC 37° Flare

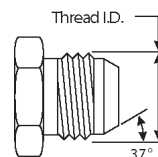
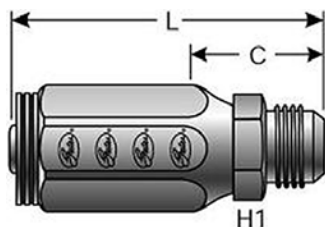

Part No.	Descr.	Prod. No.	⊖		H1	L		C		
			"	mm		"	"	"	mm	"
G27165-0606	6C1T-6RMJ	7231-22185	3/8	9.5	9/16-18	9/16	2.68	68.1	1.40	35.6
G27165-0808	8C1T-8RMJ	7231-22195	1/2	12.7	3/4-16	3/4	3.05	77.5	1.70	43.2
G27165-0810	8C1T-10RMJ	7231-22205	1/2	12.7	7/8-14	7/8	3.31	84.1	1.96	49.9
G27165-1212	12C1T-12RMJ	7231-22215	3/4	19.1	1 1/16-12	1 1/16	3.52	89.4	1.98	50.3

Female JIC 37° Flare Swivel

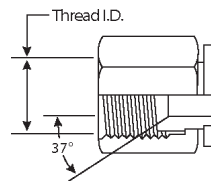
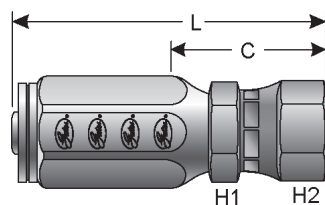

Part No.	Descr.	Prod. No.	⊖		H1	H2	L		C		
			"	mm			"	"	"	mm	"
G27170-0404	4C1T-4RFJX	7231-81215	1/4	6.4	7/16-20	9/16	9/16	2.47	62.7	1.46	37.1
G27170-0405	4C1T-5RFJX	7231-81216	1/4	6.4	1/2-20	11/16	11/16	2.58	65.5	1.57	39.9
G27170-0606	6C1T-6RFJX	7231-81217	3/8	9.5	9/16-18	3/4	3/4	2.80	71.1	1.65	41.9
G27170-0608	6C1T-8RFJX	7231-81218	3/8	9.5	3/4-16	3/4	7/8	2.91	73.9	1.76	44.7



Female JIC 37° Flare Swivel - Continued

Part No.	Descr.	Prod. No.	⊖		🌀	H1	H2	L		C	
			"	mm				"	mm	"	mm
G27170-0808	8C1T-8RFJX	7231-81219	1/2	12.7	3/4-16	13/16	7/8	3.24	82.3	1.89	48.1
G27170-0810	8C1T-10RFJX	7231-81220	1/2	12.7	7/8-14	13/16	1 1/16	3.34	84.8	1.99	50.6
G27170-1212	12C1T-12RFJX	7231-81221	3/4	19.1	1 1/16-12	1 1/8	1 1/4	3.45	87.6	1.91	48.5
G27170-1616	16C1T-16RFJX	7231-81222	1	25.4	1 5/16-12	1 3/8	1 1/2	3.90	99.1	2.22	56.4

Female JIC 37° Flare Swivel - 45° Bent Tube

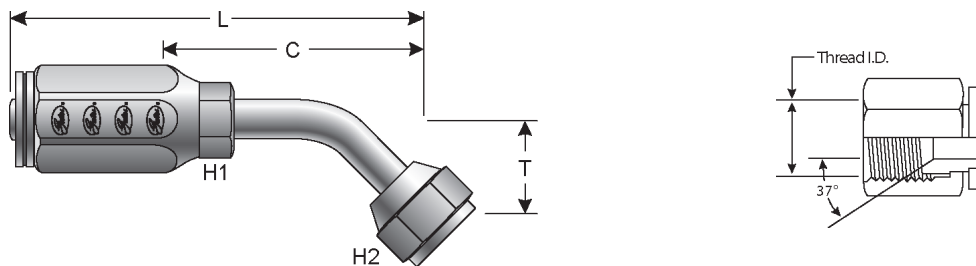

Part No.	Descr.	Prod. No.	⊖		🌀	H1	H2	T	L		C		
			"	mm					"	mm	"	mm	
G27175-0404	4C1T-4RFJX45	7231-22545	1/4	6.4	7/16-20	3/8	9/16	.33	8.4	2.80	71.1	1.79	45.5
G27175-0606	6C1T-6RFJX45	7231-22555	3/8	9.5	9/16-18	1/2	11/16	.39	10.0	3.37	85.6	1.79	45.5
G27175-0808	8C1T-8RFJX45	7231-22565	1/2	12.7	3/4-16	5/8	7/8	.55	14.0	4.11	104.4	2.10	53.3
G27175-1212	12C1T-12RFJX45	7231-22575	3/4	19.1	1 1/16-12	1 1/4	1 1/4	.78	19.8	4.70	119.4	3.16	80.3

Female JIC 37° Flare Swivel - 90° Bent Tube

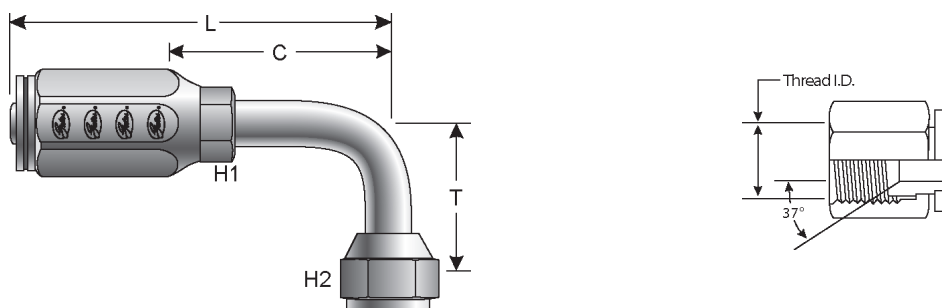

Part No.	Descr.	Prod. No.	⊖		🌀	H1	H2	T	L		C		
			"	mm					"	mm	"	mm	
G27180-0404	4C1T-4RFJX90	7231-22655	1/4	6.4	7/16-20	3/8	9/16	.68	17.3	2.69	68.3	1.68	42.7
G27180-0606	6C1T-6RFJX90	7231-22665	3/8	9.5	9/16-18	1/2	11/16	.85	21.6	3.28	83.3	2.00	50.8
G27180-0608	6C1T-8RFJX90	7231-22675	3/8	9.5	3/4-16	5/8	7/8	1.09	27.7	3.58	90.9	2.31	58.7
G27180-0808	8C1T-8RFJX90	7231-22685	1/2	12.7	3/4-16	5/8	7/8	1.09	27.7	3.86	98.1	2.51	63.8
G27180-0810	8C1T-10RFJX90	7231-22695	1/2	12.7	7/8-14	3/4	1	1.23	31.2	3.92	99.6	2.59	65.8
G27180-1212	12C1T-12RFJX90	7231-22705	3/4	19.1	1 1/16-12	1 1/4	1 1/4	1.82	46.2	4.59	116.6	3.05	77.5

EQUIPMENT
HOSE/CPLG. SELECTION
G8K COUPLINGS
GLOBAL SPIRAL COUPLINGS
STAINLESS STEEL SPIRAL
MEGACRIMP COUPLINGS
STAINLESS STEEL BRAID
POWER CRIMP COUPLINGS
FIELD ATTACHABLE G1 & G2 COUPLINGS
FIELD ATTACHABLE C5 COUPLINGS
C14 COUPLINGS
GL COUPLINGS
GLX COUPLINGS
PCTS THERMOPLASTIC COUPLINGS
POLARSEAL COUPLINGS (ACA)
POLARSEAL II COUPLINGS (ACC)
POLARSEAL II COUPLINGS (ACB)
POWER STEERING
ADAPTERS
QUICK DISCONNECT COUPLERS
BALL VALVES
LIVE SWIVEL
ASSEMBLY FABRICATION
ACCESSORIES
EQUIPMENT AND PARTS
KITS
AIR BRAKE HOSE ASSY
BRASS



EQUIPMENT
HOSE/CPLG. SELECTION
G8K COUPLINGS
GLOBAL SPIRAL COUPLINGS
STAINLESS STEEL SPIRAL
MEGACRIMP COUPLINGS
STAINLESS STEEL BRAID
POWER CRIMP COUPLINGS
FIELD ATTACHABLE G1 & G2 COUPLINGS
FIELD ATTACHABLE C5 COUPLINGS
C14 COUPLINGS
GL COUPLINGS
GLX COUPLINGS
PCTS THERMOPLASTIC COUPLINGS
POLARSEAL COUPLINGS (ACA)
POLARSEAL II COUPLINGS (ACC)
POLARSEAL II COUPLINGS (ACB)
POWER STEERING
ADAPTERS
QUICK DISCONNECT COUPLERS
BALL VALVES
LIVE SWIVEL
ASSEMBLY FABRICATION
ACCESSORIES
EQUIPMENT AND PARTS
KITS
AIR BRAKE HOSE ASSY
BRASS

Male Pipe (NPTF - 30° Cone Seat)

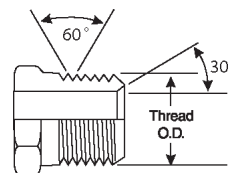
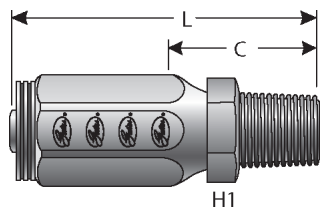

Part No.	Descr.	Prod. No.	⌀		H1	L		C		
			"	mm		"	mm	"	mm	
G28100-0402	4C2AT-2RMP	7231-81247	1/4	6.4	1/8-27	1/2	2.30	58.4	1.23	31.2
G28100-0404	4C2AT-4RMP	7231-81223	1/4	6.4	1/4-18	9/16	2.52	64.0	1.45	36.8
G28100-0604	6C2AT-4RMP	7231-81248	3/8	9.5	1/4-18	9/16	2.68	68.1	1.45	36.8
G28100-0606	6C2AT-6RMP	7231-81224	3/8	9.5	3/8-18	11/16	2.53	64.3	1.30	33.0
G28100-0806	8C2AT-6RMP	7231-81249	1/2	12.7	3/8-18	11/16	3.05	77.5	1.63	41.4
G28100-0808	8C2AT-8RMP	7231-81225	1/2	12.7	1/2-14	7/8	3.06	77.7	1.64	41.7
G28100-0812	8C2AT-12RMP	7231-81251	1/2	12.7	3/4-14	1 1/16	3.13	79.5	1.71	43.4
G28100-1212	12C2AT-12RMP	7231-81226	3/4	19.1	3/4-14	1 1/16	3.19	81.0	1.65	41.9
G28100-1616	16C2AT-16RMP	7231-81227	1	25.4	1-11 1/2	1 3/8	3.78	96.0	2.04	51.8
G28100-2020	20C2AT-20RMP	7231-81228	1 1/4	31.8	1 1/4-11 1/2	1 3/4	4.59	116.6	2.49	63.3
G28100-2424	24C2AT-24RMP	7231-81252	1 1/2	38.1	1 1/2-11 1/2	2	5.18	131.6	2.68	68.1

Male Pipe Swivel (NPTF - without 30° Cone Seat)

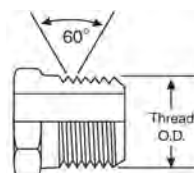
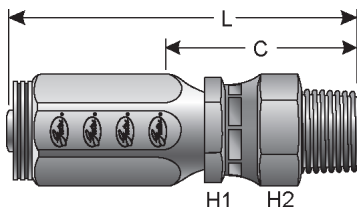

Part No.	Descr.	Prod. No.	⌀		H1	H2	L		C		
			"	mm			"	mm	"	mm	
G28105-0404	4C2AT-4RMPX	7231-22495	1/4	6.4	1/4-18	7/16	11/16	3.18	80.8	2.11	53.6
G28105-0606	6C2AT-6RMPX	7231-22505	3/8	9.5	3/8-18	5/8	7/8	3.51	89.2	2.27	57.7
G28105-0808	8C2AT-8RMPX	7231-22515	1/2	12.7	1/2-14	3/4	1	3.99	101.4	2.56	65.0
G28105-1212	12C2AT-12RMPX	7231-22525	3/4	19.1	3/4-14	1 1/16	1 5/16	4.27	108.5	2.73	69.3



Male O-Ring Boss

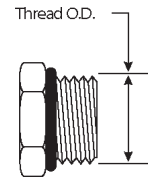
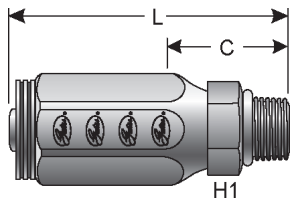

Part No.	Descr.	Prod. No.	⌀		H1	L		C		
			"	mm		"	"	"	mm	"
G28120-0606	6C2AT-6RMB	7231-22355	3/8	9.5	9/16-18	11/16	2.52	64.0	1.28	32.5
G28120-0608	6C2AT-8RMB	7231-22365	3/8	9.5	3/4-16	7/8	2.59	65.8	1.36	34.5
G28120-0808	8C2AT-8RMB	7231-22375	1/2	12.7	3/4-16	7/8	2.87	72.9	1.45	36.8
G28120-0810	8C2AT-10RMB	7231-22385	1/2	12.7	7/8-14	1	3.11	79.0	1.59	40.4

Male JIC 37° Flare

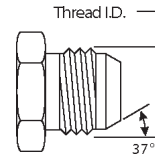
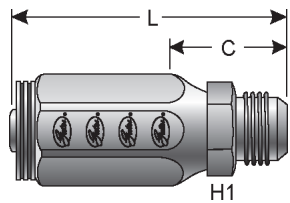

Part No.	Descr.	Prod. No.	⌀		H1	L		C		
			"	mm		"	"	"	mm	"
G28165-0606	6C2AT-6RMJ	7231-22025	3/8	9.5	9/16-18	9/16	2.68	68.1	1.45	36.8
G28165-0808	8C2AT-8RMJ	7231-22045	1/2	12.7	3/4-16	3/4	3.05	77.5	1.63	41.4
G28165-0810	8C2AT-10RMJ	7231-22055	1/2	12.7	7/8-14	7/8	3.31	84.1	1.89	48.1
G28165-1212	12C2AT-12RMJ	7231-22065	3/4	19.1	1 1/16-12	1 1/16	3.52	89.4	1.98	50.3

Female JIC 37° Flare Swivel

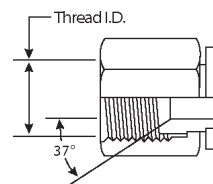
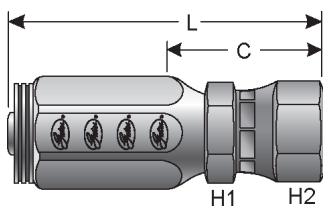

Part No.	Descr.	Prod. No.	⌀		H1	H2	L		C		
			"	mm			"	"	"	mm	"
G28170-0404	4C2AT-4RFJX	7231-81229	1/4	6.4	7/16-20	9/16	9/16	2.47	62.7	1.40	35.6
G28170-0405	4C2AT-5RFJX	7231-81230	1/4	6.4	1/2-20	11/16	11/16	2.58	65.5	1.57	39.9
G28170-0606	6C2AT-6RFJX	7231-81231	3/8	9.5	9/16-18	3/4	3/4	2.80	71.1	1.56	39.6
G28170-0608	6C2AT-8RFJX	7231-81232	3/8	9.5	3/4-16	3/4	3/4	2.91	73.9	1.67	42.4
G28170-0808	8C2AT-8RFJX	7231-81233	1/2	12.7	3/4-16	13/16	7/8	3.24	82.3	1.82	46.2
G28170-0810	8C2AT-10RFJX	7231-81234	1/2	12.7	7/8-14	1 1/16	1 1/16	3.34	84.8	1.92	48.8

EQUIPMENT
HOSE/CPLG. SELECTION
G8K COUPLINGS
GLOBALSPIRAL COUPLINGS
STAINLESS STEEL SPIRAL
MEGACRIMP COUPLINGS
STAINLESS STEEL BRAID
POWER CRIMP COUPLINGS
FIELD ATTACHABLE G1 & G2 COUPLINGS
FIELD ATTACHABLE C5 COUPLINGS
C14 COUPLINGS
GL COUPLINGS
GLX COUPLINGS
PCTS THERMOPLASTIC COUPLINGS
POLARSEAL COUPLINGS (ACA)
POLARSEAL II COUPLINGS (ACC)
POLARSEAL II COUPLINGS (ACB)
POWER STEERING
ADAPTERS
QUICK DISCONNECT COUPLERS
BALL VALVES
LIVE SWIVEL
ASSEMBLY FABRICATION
ACCESSORIES
EQUIPMENT AND PARTS
KITS
AIR BRAKE HOSE ASSY
BRASS



EQUIPMENT
HOSE/CPLG. SELECTION
G8K COUPLINGS
GLOBAL SPIRAL COUPLINGS
STAINLESS STEEL SPIRAL
MEGACRIMP COUPLINGS
STAINLESS STEEL BRAID
POWER CRIMP COUPLINGS
FIELD ATTACHABLE G1 & G2 COUPLINGS
FIELD ATTACHABLE C5 COUPLINGS
C14 COUPLINGS
GL COUPLINGS
GLX COUPLINGS
PCTS THERMOPLASTIC COUPLINGS
POLARSEAL COUPLINGS (ACA)
POLARSEAL II COUPLINGS (ACC)
POLARSEAL II COUPLINGS (ACB)
POWER STEERING
ADAPTERS
QUICK DISCONNECT COUPLERS
BALL VALVES
LIVE SWIVEL
ASSEMBLY FABRICATION
ACCESSORIES
EQUIPMENT AND PARTS
KITS
AIR BRAKE HOSE ASSY
BRASS

Female JIC 37° Flare Swivel - Continued

Part No.	Descr.	Prod. No.	⊖		H1	H2	L		C		
			"	mm			"	mm	"	mm	
G28170-1212	12C2AT-12RFJX	7231-81235	3/4	19.1	1 1/16-12	1 1/8	1 1/2	3.45	87.6	1.91	48.5
G28170-1616	16C2AT-16RFJX	7231-81236	1	25.4	1 5/16-12	1 3/8	1 1/2	3.90	99.1	2.16	54.9
G28170-2020	20C2AT-20RFJX	7231-81237	1 1/4	31.8	1 5/8-12	1 7/8	2	4.85	123.2	2.74	69.6
G28170-2424	24C2AT-24RFJX	7231-81254	1 1/2	38.1	1 7/8-12	2 1/8	2 1/4	5.26	133.6	2.76	70.1

Female JIC 37° Flare Swivel - 45° Bent Tube

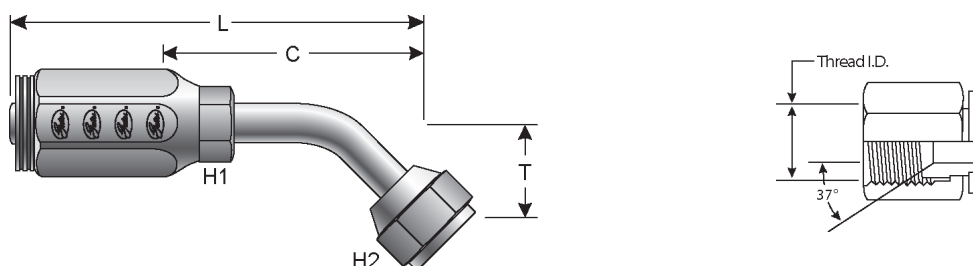

Part No.	Descr.	Prod. No.	⊖		H1	H2	T		L		C		
			"	mm			"	mm	"	mm	"	mm	
G28175-0404	4C2AT-4RFJX45	7231-22595	1/4	6.4	7/16-20	3/8	9/16	.33	8.4	2.80	71.1	1.73	43.9
G28175-0606	6C2AT-6RFJX45	7231-22605	3/8	9.5	9/16-18	1/2	11/16	.39	10.0	3.37	85.6	2.14	54.4
G28175-0808	8C2AT-8RFJX45	7231-22615	1/2	12.7	3/4-16	5/8	7/8	.55	14.0	4.11	104.4	2.68	68.1
G28175-1212	12C2AT-12RFJX45	7231-22625	3/4	19.1	1 1/16-12	7/8	1 1/4	.78	19.8	4.70	119.4	3.16	80.3

Female JIC 37° Flare Swivel - 90° Bent Tube

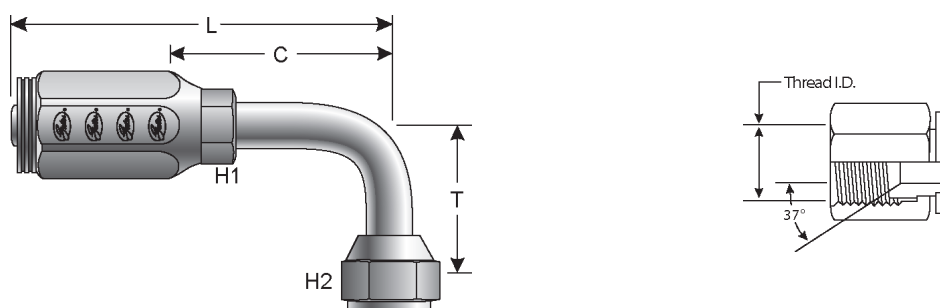

Part No.	Descr.	Prod. No.	⊖		H1	H2	T		L		C		
			"	mm			"	mm	"	mm	"	mm	
G28180-0404	4C2AT-4RFJX90	7231-22755	1/4	6.4	7/16-20	3/8	9/16	.68	17.3	2.69	68.3	1.62	41.2
G28180-0606	6C2AT-6RFJX90	7231-22765	3/8	9.5	9/16-18	1/2	11/16	.85	21.6	3.28	83.3	2.04	51.8
G28180-0608	6C2AT-8RFJX90	7231-22775	3/8	9.5	3/4-16	5/8	7/8	1.09	27.7	3.58	90.9	2.35	59.7
G28180-0808	8C2AT-8RFJX90	7231-22785	1/2	12.7	3/4-16	5/8	7/8	1.09	27.7	3.86	98.1	2.42	61.5
G28180-0810	8C2AT-10RFJX90	7231-22795	1/2	12.7	7/8-14	3/4	1	1.23	31.2	3.92	99.6	2.50	63.5
G28180-1212	12C2AT-12RFJX90	7231-22805	3/4	19.1	1 1/16-12	7/8	1 1/4	1.82	46.2	4.59	116.6	3.05	77.5



Female Flat-Face O-Ring Swivel

SAE J1453 O-Ring Face Seal.

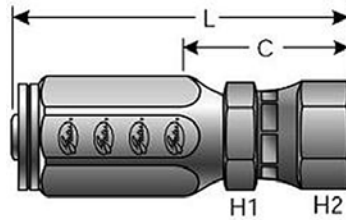

Part No.	Descr.	Prod. No.	⌀		🌀	H1	H2	L		C	
			"	mm				"	mm	"	mm
G28230-0404	4C2AT-4RFFORX	7231-14105	1/4	6.4	9/16-18	43/64	43/64	2.50	63.5	1.43	36.3
G28230-0606	6C2AT-6RFFORX	7231-14125	3/8	9.5	11/16-16	7/8	7/8	2.88	73.2	1.64	41.7
G28230-0808	8C2AT-8RFFORX	7231-14145	1/2	12.7	13/16-16	61/64	61/64	3.37	85.6	1.94	49.3
G28230-1212	12C2AT-12RFFORX	7231-14165	3/4	19.1	1 3/16-12	1 1/8	1 13/32	2.03	51.6	3.57	90.7

Female Flat-Face O-Ring Swivel - 45° Bent Tube

SAE J1453 O-Ring Face Seal.

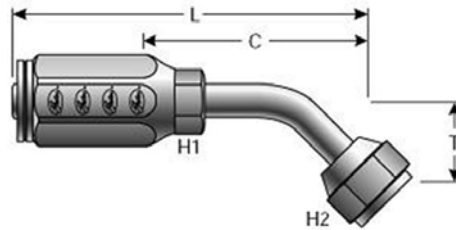

Part No.	Descr.	Prod. No.	⌀		🌀	H1	H2	T	L		C		
			"	mm					"	mm	"	mm	
G28234-0404	4C2AT-4RFFORX45S	7231-14305	1/4	6.4	9/16-18	3/8	9/16	.68	17.3	2.69	68.3	1.62	41.2
G28234-0606	6C2AT-6RFFORX45S	7231-14325	3/8	9.5	11/16-16	1/2	11/16	.85	21.6	3.28	83.3	2.04	51.8
G28234-0808	8C2AT-8RFFORX45S	7231-14345	1/2	12.7	13/16-16	5/8	7/8	1.09	27.7	3.86	98.1	2.42	61.5
G28234-1212	12C2AT-12RFFORX45S	7231-14365	3/4	19.1	1 3/16-12	7/8	1 1/4	1.82	46.2	4.59	116.6	3.05	77.5

EQUIPMENT
HOSE/CPLG. SELECTION
G8K COUPLINGS
GLOBALSPIRAL COUPLINGS
STAINLESS STEEL SPIRAL
MEGACRIMP COUPLINGS
STAINLESS STEEL BRAID
POWER CRIMP COUPLINGS
FIELD ATTACHABLE G1 & G2 COUPLINGS
FIELD ATTACHABLE C5 COUPLINGS
C14 COUPLINGS
GL COUPLINGS
GLX COUPLINGS
PCTS THERMOPLASTIC COUPLINGS
POLARSEAL COUPLINGS (ACA)
POLARSEAL II COUPLINGS (ACC)
POLARSEAL II COUPLINGS (ACB)
POWER STEERING
ADAPTERS
QUICK DISCONNECT COUPLERS
BALL VALVES
LIVE SWIVEL
ASSEMBLY FABRICATION
ACCESSORIES
EQUIPMENT AND PARTS
KITS
AIR BRAKE HOSE ASSY
BRASS



Female Flat-Face O-Ring Swivel - 90° Bent Tube

SAE J1453 O-Ring Face Seal.

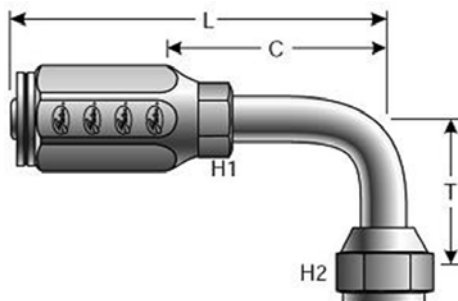

Part No.	Descr.	Prod. No.	⊖		🌀	H1	H2	T		L		C	
			"	mm				"	"	"	mm	"	mm
G28239-0404	4C2AT-4RFFORX90S	7231-14505	1/4	6.4	9/16-18	3/8	9/16	.68	17.3	2.69	68.3	1.62	41.2
G28239-0606	6C2AT-6RFFORX90S	7231-14525	3/8	9.5	11/16-16	1/2	11/16	.85	21.6	3.28	83.3	2.04	51.8
G28239-0808	8C2AT-8RFFORX90S	7231-14545	1/2	12.7	13/16-16	5/8	7/8	1.09	27.7	3.86	98.1	2.42	61.5
G28239-1212	12C2AT-12RFFORX90S	7231-14565	3/4	19.1	1 3/16-12	—	7/8	1.88	40.8	4.54	115.3	3.00	76.2

EQUIPMENT
HOSE/CPLG. SELECTION
G8K COUPLINGS
GLOBAL SPIRAL COUPLINGS
STAINLESS STEEL SPIRAL
MEGACRIMP COUPLINGS
STAINLESS STEEL BRAID
POWER CRIMP COUPLINGS
FIELD ATTACHABLE G1 & G2 COUPLINGS
FIELD ATTACHABLE C5 COUPLINGS
C14 COUPLINGS
GL COUPLINGS
GLX COUPLINGS
PCTS THERMOPLASTIC COUPLINGS
POLARSEAL COUPLINGS (ACA)
POLARSEAL II COUPLINGS (ACC)
POLARSEAL II COUPLINGS (ACB)
POWER STEERING
ADAPTERS
QUICK DISCONNECT COUPLERS
BALL VALVES
LIVE SWIVEL
ASSEMBLY FABRICATION
ACCESSORIES
EQUIPMENT AND PARTS
KITS
AIR BRAKE HOSE ASSY
BRASS